

Statistics and Data Science (BA): Sample Curriculum

First Year

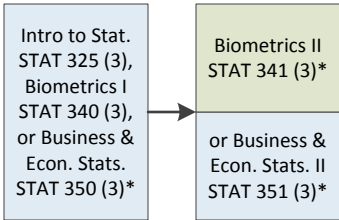

* STAT courses at the 400-level or higher may replace either or both of the 300-level STAT courses in this sequence, but credit may be received for only one of STAT 701 or STAT 703

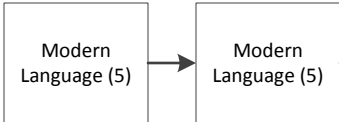
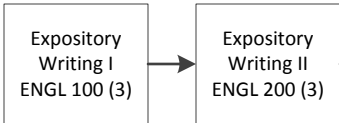
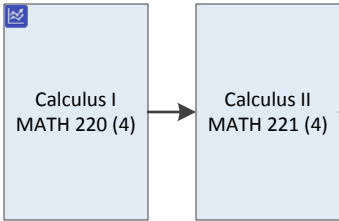

**** The B.A. degree requires completion of a "Level 4" foreign language course (excluding "Conversation 4A" courses) OR completion of two semesters each of two different languages (IF one of the languages is only offered for two semesters). The credit hours and course counts may also be reduced if the student directly enters and completes upper-level courses to demonstrate proficiency.

Sophomore Year

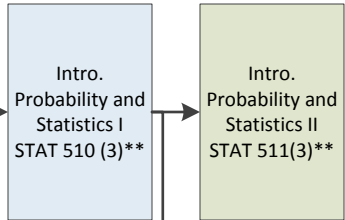

** STAT 770 and STAT 771 may replace STAT 510 and STAT 511, respectively, subject to departmental approval.

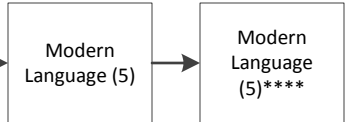
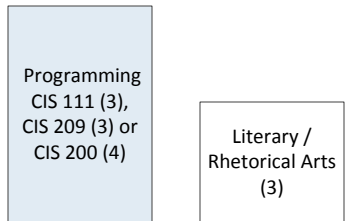
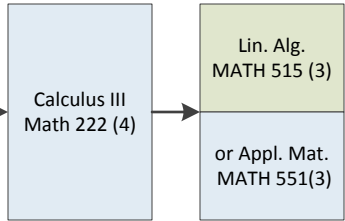

Junior Year

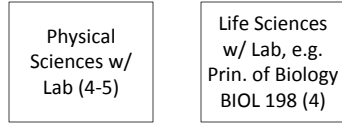
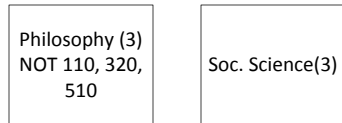
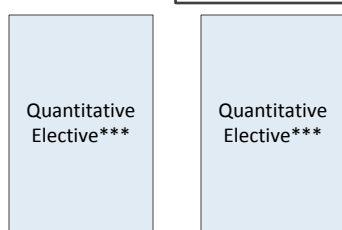
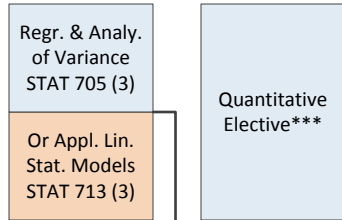

The following remaining K-State 8 requirements should be considered when selecting courses for the College-level general education requirements:

- Aesthetic Experience and Interpretive Understanding
- Ethical Reasoning and Responsibility
- Global Issues and Perspectives
- Historical Perspectives
- Human Diversity within the U.S.
- Natural and Physical Sciences
- Social Sciences

Senior Year

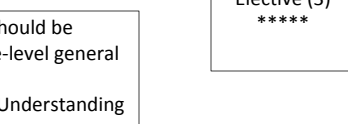
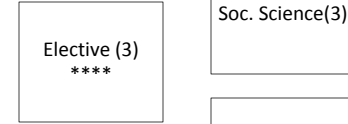
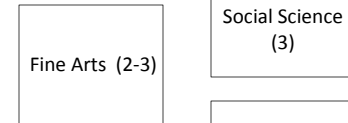
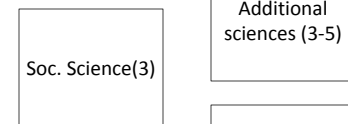
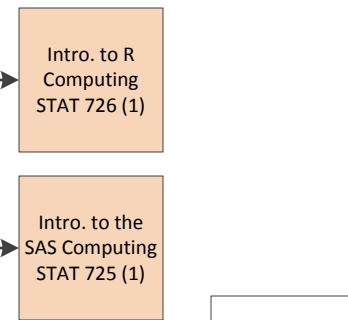
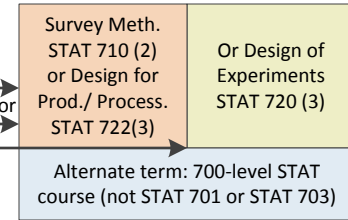

Notes:

The following also needs to be considered in the College-level general education requirements:

- The social science courses need to be from three different disciplines.
- One social science course must be 500+ or carry a prerequisite in the same department.
- The foreign language fulfills the International Overlay requirement.

*** The quantitative electives must bring the statistics core classes to 50 credits (the number of classes required to do this may vary). Courses must be at the 400-level or above and may include IMSE 541, IMSE 785, ECON 630, math, computer science, Statics (excluding 701 and 703) or a course in another area with substantial quantitative content.

KEY

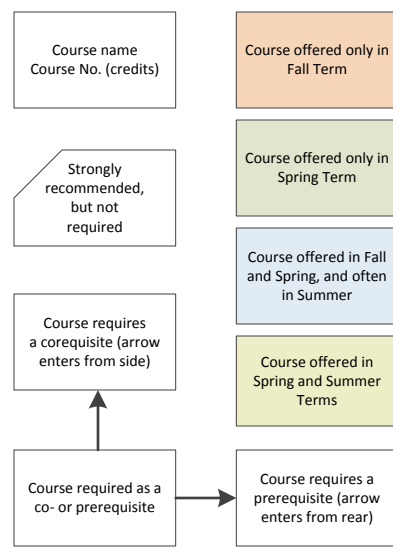

**** The BA degree also requires 120 credits; 45 in upper-division courses. The number of free electives required to meet these criteria will vary by student.

Total Hours: 120+

15 credits 16 credits 15-16 credits 14 credits 16-17 credits 16 credits 12-14 credits 15-17 credits